

WOODHAVEN

365 Deluxe Cabinet

Please Read Carefully!



Router Table, Fence & Accessories Not Included

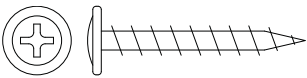

Part#	Description	Qty.
CAB050	1/4" Screw	18

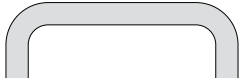

Part#	Description	Qty.
CAB045	Drawer Pull	9

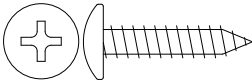

Part#	Description	Qty.
STP001	3/4" Screw	8



Part#	Description	Qty.
5620B	T-Nut	4



Part#	Description	Qty.
CAB040	Leg Leveler	4

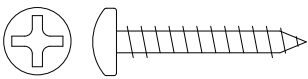

Part#	Description	Qty.
SPB005	3/4" Screw	4

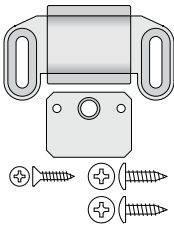

Part#	Description	Qty.
CAB060	Door Catch	3

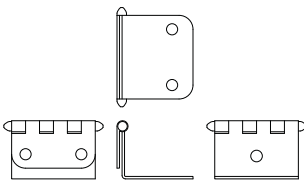

Part#	Description	Qty.
CAB055	Door Hinge	3

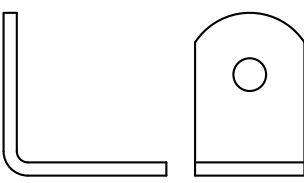

Part#	Description	Qty.
CAB010	Angle Bracket	4

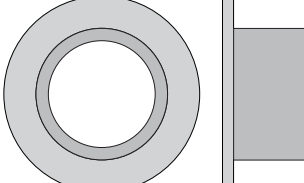

Part#	Description	Qty.
281	Dust Port	1

BEFORE BEGINNING

Identify and verify that you have all the parts listed. Read the instructions at least once, familiarizing yourself with the parts, before beginning. Tools needed for assembly are a Phillips screwdriver, assorted clamps, glue, screws or nails (if desired) and finishing supplies. Dry fit the various assemblies to avoid any problems during glue-up. Arrange the parts like the illustration on page 4 to speed assembly time.

Step 1: Apply glue to the bottom dado of the middle shelf and the dado in the bottom panel. Insert the bottom divider into the dado of the middle shelf and the upper shelf. This forms an "H" shaped assembly. Clamp the parts together and check for square. Use nails or screws if desired. **See fig 1.**

Step 2: Apply glue to the two lower dados of the side panels. Insert the "H" shaped assembly into the dados. Clamp and check for square. Use nails or screws if desired. **See fig 2.**

Step 3: Apply glue to the two dados on each of the top dividers and install the four drawer shelves into the two top dividers and clamp. Use nails or screws if desired. **See fig 3.**

Step 4: Apply glue in the upper two dados of the side panels and the middle shelf. Install both drawer divider sub-assemblies in the cabinet. Clamp the assemblies together and check for square. Use nails or screws if desired. **See fig. 4.**

Step 5: Apply glue in the upper rabbet of the side panel and the dados in top panel. Install the top panel between the sides and on top of the two top dividers. Clamp together and check for square. Use nails or screws if desired. Let everything dry before proceeding. **See fig. 5.**

Step 6: On each end of the skid, measure back from the

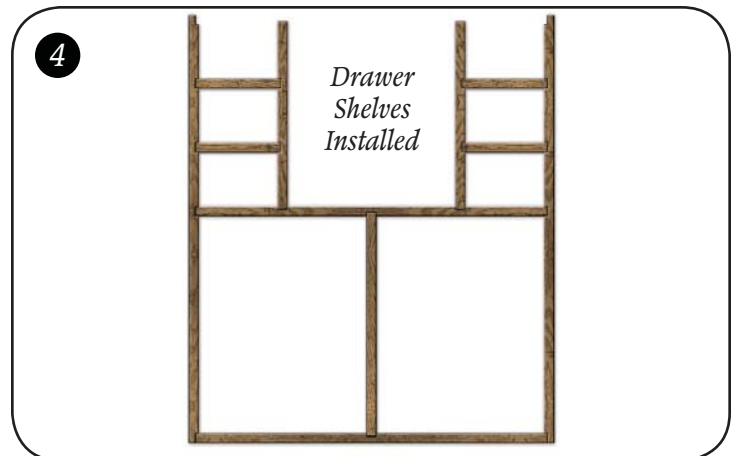
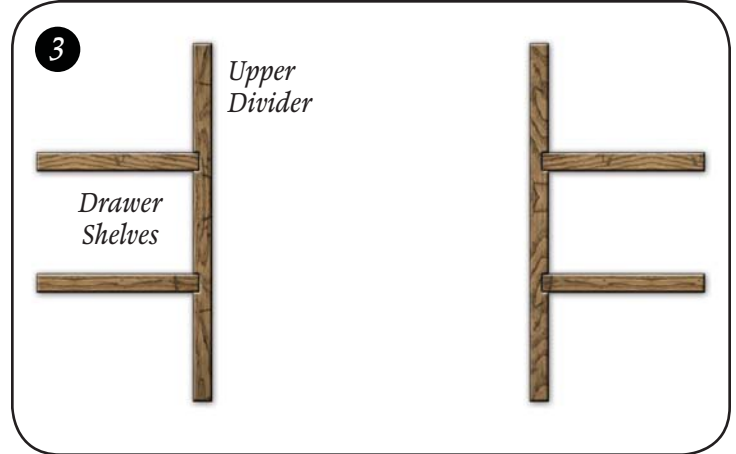
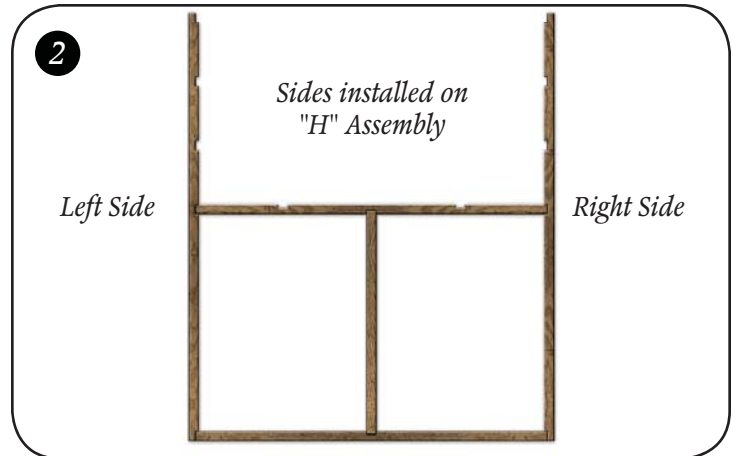
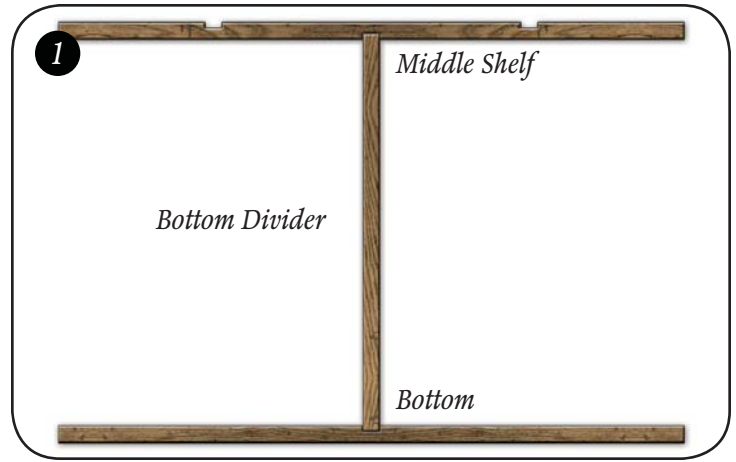

end 1", centered side to side and drill a 5/16" diameter x 1" deep hole. Insert the T-nuts (**5620B**) into the 5/16" holes, screw leg levelers (**CAB040**) into them. Turn the cabinet over and glue the skids (use nails or screws if desired) on the outside edges of the cabinet bottom, then turn the cabinet right side up. **See fig. 6.**

Step 7: Plan where you would like an access hole for the router cord. The hole needs to go in the upper back panel. Dry fit the panel in place and mark the hole location and cut or drill the cord opening. **See fig. 7.**

If desired, fasten the dust port (**281**) to the upper back. Trace the opening and cut with a jigsaw or hole saw. Use 3/4" screws (**SPB005**) to attach the dust port to the back. **See fig. 7.**

Apply glue to the rabbet on the back of the cabinet. Install the upper and lower back to the back of the cabinet using finish nails.

You can choose to not cover the back of the router compartment. If doing so, cut two strips from the upper back panel wide enough to cover the space behind the drawers.

INSTALL HARDWARE

Step 8: The doors are sized to allow the use of mortise type hinges, which are not provided. The doors will need to be trimmed slightly to allow the installation of the flush mounted door hinges we include. If you want to use the hinges we provide, trim the long edge of the doors an amount equal to the thickness of the closed hinge. Mount the door hinges (**CAB055**) to the doors and then the doors to the cabinet.

Locate and mount door catches (**CAB060**). Mark and install the handles (**CAB045**) using 1-1/4" screws (**CAB050**).

ASSEMBLE DRAWERS

Step 9: Dry fit the drawers before gluing. Glue and clamp the drawer sides to the drawer fronts and backs. If desired, use nails or screws to reinforce the joints. Slide the bottom in the grooves of the drawer sides and nail or screw the bottom to the drawer back. Check the drawer for square. **See fig. 8.**

Test fit the drawer in the opening. Sand the sides if necessary so it slides easily. If desired, add a spacer block to the drawer back so the drawer front is flush with the cabinet face when closed. Mount the drawer pulls (**CAB045**) using the 1-1/4" screws (**CAB050**).

FINISH

Step 10: Sand and finish the unit as desired. If you are finishing before assembly, be sure not to get anything on the edges that will be glued.

MOUNTING TABLE

If you have an MDF Router Table, position the four 1" angle brackets (**CAB010**) against the sides and near the four corners of the cabinet. Drill 1/8" pilot holes

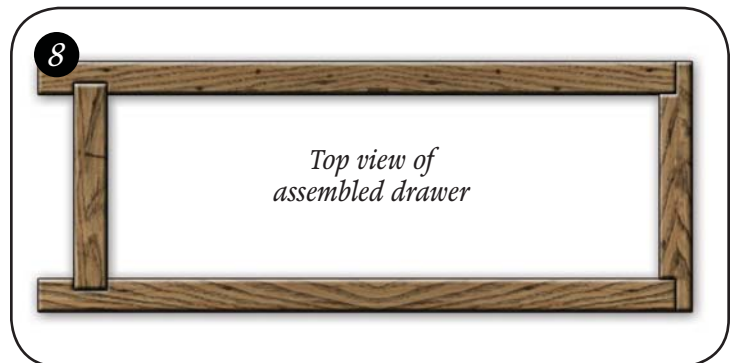
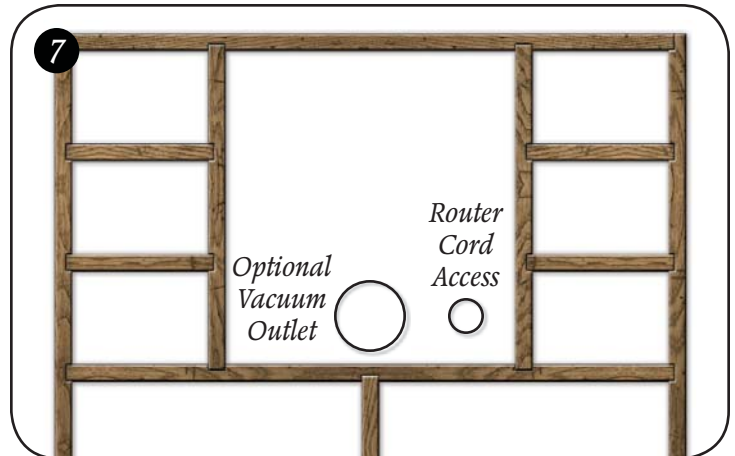

5/8" deep and attach the brackets to the sides with the 3/4" (**STP001**) wood screws. Turn your router table upside down and center the cabinet (upside down) on the table, with the brackets resting on the underside of the MDF router table. Drill 1/8" pilot holes and attach the brackets to the MDF router table with 3/4" wood screws.

If you have a Phenolic Router Table, use the machine screws and T-nuts included in its hardware package to attach the top to the stand where the T-slots in the Phenolic Table allow.

©Copyright WOODHAVEN INC. 11/8/10
(800) 344-6657 or WWW.WOODHAVEN.COM

365 Parts

All 365 parts shown on this page are 18mm ply except for the backs (1/4" MDF), 6 drawer bottoms (1/4" MDF) & 6 pairs of drawer sides (12mm ply - not shown).

